

MAINTENANCE

MODEL: DMNC-280

YUASA INTERNATIONAL

INDEX

DESCRIPTION	PAGE
1. SPECIFICATION	2
OUTSIDE DIMENSION LAYOUT	3
2. INSPECTION REPORT	4
3. PREPARATION FOR OPERATION	5
3-1 .LUBRICATING OIL	5
3-2.PNEUMATIC FOR TABLE CLAMPING	5
4. TRIAL RUNNING	6
4-1 .PREPARATION FOR MOTOR DRIVING	6
4-2.TRIAL RUNNING	6
4-3.DISTANCE SETTING UP FOR THE SPINDLE	6
5. WORK-PIECE MOUNTING	7
6. THE BACKLASH ADJUSTING FOR WORM SHAFT AND GEAR	8
6-1 .BACKLASH MEASURING	9
6-2.AMOUNT OF BACKLASH ADJUSTING	10
7. CUSTRICTION FOR ZERO-POSITION	11
7-1 .CUSTRICTION FOR ZERO-POSITION	12
7-2.THE ADJUSTING OF DOG POSITION	12
8. OPERATION FOR CHANGING HYDRAULIC / PNEUMATIC	12
9. EXPLODED VIEW AND PART LIST	13

I. SPECIFICATION

CNC ROTARY TABLE SPECIFICATION

	Item	Unit	DMNC-280	Remark
1	Table Diameter	mm	$\Phi 280$	
2	Center High in Vertical	mm	190	
3	Overall High in Vertical	mm	340	
4	Overall Length	mm	520	P5
5	Overall Width	mm	220	
6	Dia. For Through Hole	mm	$\Phi 91$	
7	Dia. For Based Hole	mm	42H7	
8	Width for Guide Block	mm	18h7	
9	Width for T-Slot	mm	12H7	
10	Servo Motor	Sanyo	P50B08075	
		Fanuc	$\alpha 81$	
11	Gear Ratio		1:120	
12	Max. Indexing Resolution	Degree	0.001	
13	Max. Speed for Rotating	r.p.m.	16.7	2000r.p.m
14	Max. Loading Weight	Kg	200	
15	Max. Machine Force	kg-m	80	
16	Positioning Accuracy	sec	20	
17	Repeatability	sec	± 2	
18	Max. Braking Torque	Kg-m	35	Pneumatic 6kg/cm ²
19	New Weight	kg	120	

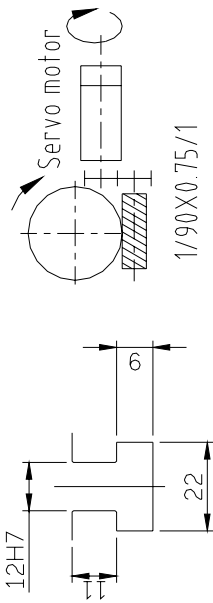
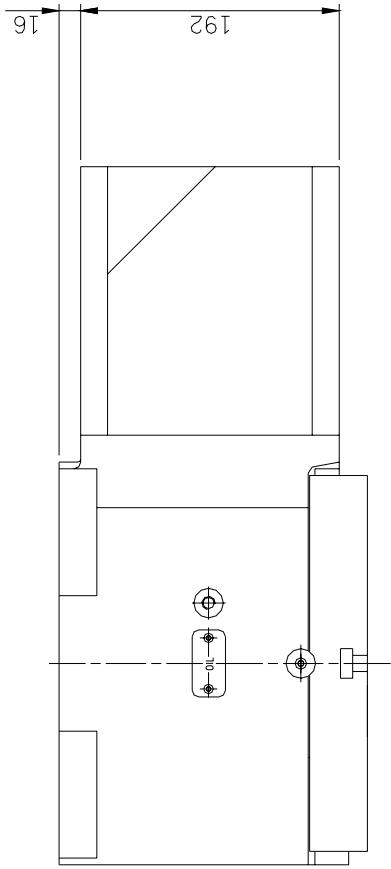

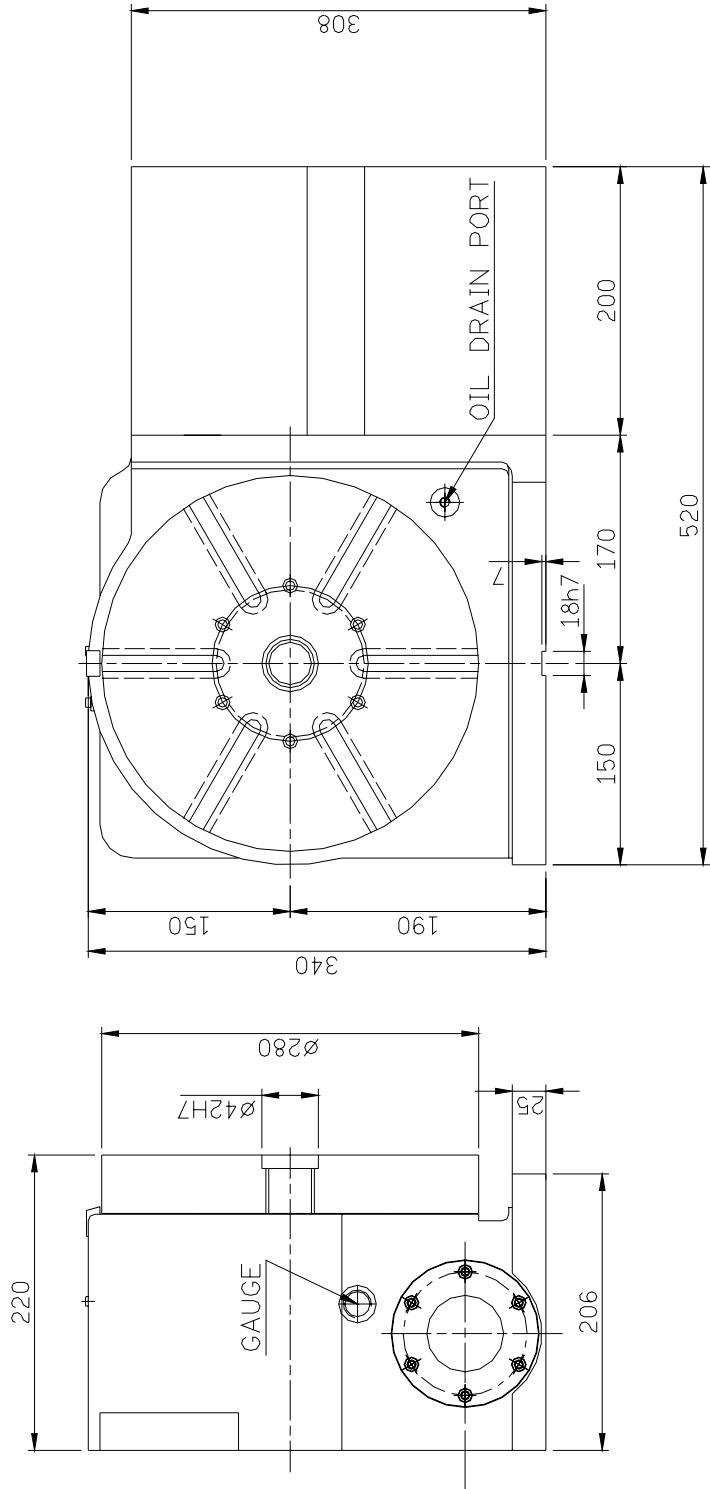

Transmission system

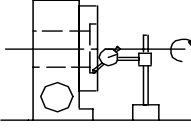
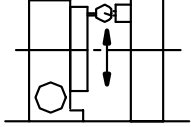
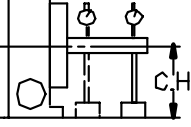

2. INSPECTION REPORT

CNC ROTARY TABLE INSPECTION REPORT

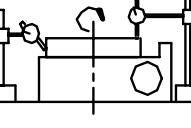
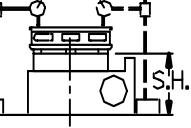
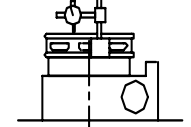
NO.	INSPECTION ITEM	Model	DMNC 280	Measuring
1	Centering Concentricity	Inlet Side	0.01	
2	The perpendicularity between table top and bottom	Length 300mm	0.02	
3	Parallelism of center axe and lower	Length 300mm	0.02	
4	Center High		190	
5	Parallelism for center axe of through hole and base surface	Length 300mm	0.02	
6	Deviation for center axe of through hole and base surface	Length 300mm	0.02	
7	Table Warping / Rotation	Max. Dia.	0.02	
8	Parallelism between table and bottom base	Overall Length	0.02	
9	Table height from table top to bottom base		220	
10	Flatness of upper surface	Overall Length	0.02	
11	Indexing Accuracy	Cumulated	20"	Measured by Optical Devise
12	Repeatability Accuracy	Cumulated	±2"	

[3] PREPARATION FOR OPERATION

3-1 Lubricating Oil

- (1) Select the lubricating oil which has the features such as strong oil film, strong rust proof and good stability of oxidation. Also viscosity grade should be around ISO, VG100-150. Since the same oil circulates among worm, wheel and other mechanical parts, purchase the quality oil so that the unit can operate in good condition for many years to come.

***** Recommended oil *****

Jomo - Lathus 100 (or150)
Mobil - Gear 629
Shell - Omela Oil 100 (or150)
Esso - Spartan 100 (or 150)

- (2) When putting the oil in the unit, make sure to clean the area of oil inlet so that dirt or chip won't get into the system. Once they get into, they will not only ruin the worm and wheel gear drive system, but also damage other mechanism in the short period of time.
- (3) Put the oil slowly up to the center line of the gage. The amount of oil you are putting in is very important, and make sure to put neither too much nor too little. When checking the oil level, check approximately 30 minutes after stopped the operation.
- (4) Change the entire oil with fresh one in once every six months. When draining the oil completely, set the unit in horizontal position to enable easy draining from the unit

3-2. Pneumatic For Table Clamping

- (1) Connect the hose with hydraulic inlet and supply the pressurized oil. Although clamping mechanism is designed to stand for max. 8 kg/cm^2 of pneumatic pressure and 6 kg/cm^2 is safety value, however, plenty good to obtain the sufficient clamping force. The relationship between hydraulic pressure and clamping force is shown below and select the proper hydraulic pressure to your need.

Note: Apply a quality hydraulic hose to sustain the pressure well.

[4]TRIAL RUNNING

After making sure the preparation, let's operate the rotary table with the following steps:

- 4-1. Before starting motor driving, check the following points:
 - A. AS it is important to make a trial running under free from the load, do not mount any work piece, jig, fixture or even chuck on the table surface.
 - B. Check the program whether N/C is providing the correct signals.
 - C. Repeat clamp and unclamp and make sure whether their Signals are executed accordingly. When the motor operates, clamp must be off, "UNCLAMP".

Note: Do not turn the table while clamp is "ON".

4-2. Trial Running

- A. When rotating the table either clockwise or counterclockwise, start out slowly and then increase the speed (R.P.M.).
- B. Give plenty of warn-up time, 20 to 30 minutes at an initial installation.

4-3. Setting the distance of grid shift on zero-return with the zero-return signal from N/C.

- A. The table returns to the origin very accurately in a fixed rotating direction..... generally speaking in clockwise direction looking from the table with the following procedures:
 - a. The table starts to rotate at the rapid feed.
 - b. When it hits the dog, micro switch activates and slows down the speed on the level which can execute an accurate sudden stop and positioning at any time.
 - c. After slowing down the speed, the signal from the motor detector stops the table at the position of origin.
- B. Zero-return mechanism is set to reduce the speed at just before the T slot on the table in vertical position becomes parallel to the rotary table base.
- C. Repeat the zero-return several times and check if the table stops at position as programmed.

Note: Generally speaking, the zero-return is set at the position where T slot of the table becomes parallel to the base of the table becomes parallel to the base of rotary table. If there's any difference, that is the amount to be off-set in the N/C as the grid shift of zero-return.

HOME POSITION INDICIATING

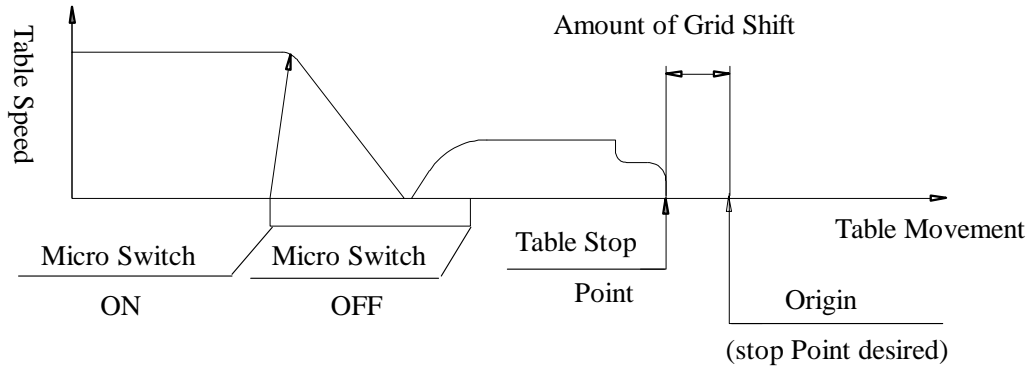

[5] MOUNTING WROKPIECE

When mounting a work piece on the rotary table , make sure the following points to avoid operator's accident, cutter or machine damages:

- 5-1. Check the table face whether any return, nick, dent, etc. exist or not.
- 5-2. Avoid of mount the work piece directly on the table which has poor flatness or perpendicularity. They may strain the table and prevent it from a smooth rotation, and which may result very poor indexing accuracy.

Note: Provide the maximum bearing surface to the work piece by even shimming up if necessary.

- 5-3. If the work piece is mounted on the rotary table at the off-centered position, it may cause inaccurate indexing.

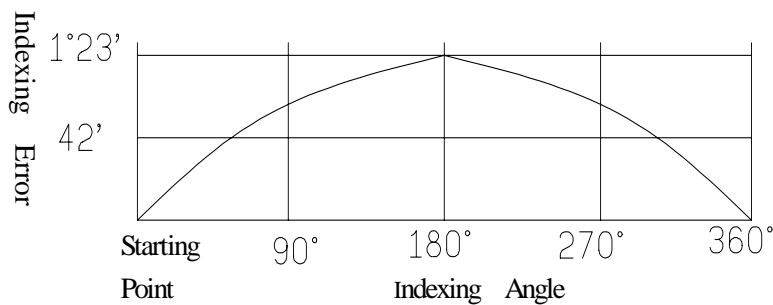
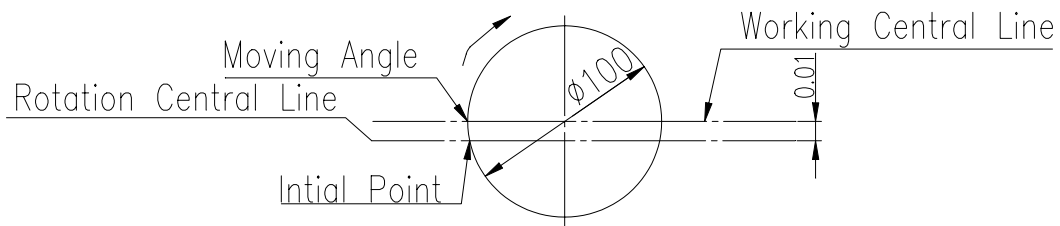

5-4. Location of work piece clamping may be restricted depending upon the shape of work piece or cutting conditions, however, clamp down firmly on the surface of rotary table at the locations spaced out equally. The smaller the bearing surface may require for the more number of clampings to stabilize the work piece without straining the table.

Note: If it is a manual rotary table, you can feel whether the rotary table is strained or not due to uneven clamping of work piece, however, when it comes to N/C rotary table, you just don't get that kind of feeling at all. Therefore, an extra caution must be taken for work piece must be taken for work piece clamping.

[6] BACKLASH ADJUSTMENT OF WORM GEAR

The Worm Gear is split in the middle and sandwiches wheel teeth from both directions to establish a perfect gear engagement of every single tooth.

The method of backlash adjustment is that by twisting both right and left hand side worms, inside of each worm tooth becomes closer to outside of each wheel tooth, and thus backlash can be adjusted to the most ideal value at 0.005 ~ 0.008m/m.

Too much of backlash means poor indexing accuracy and causes chattering in machining and poor finish.

Again too little or no backlash may cause the serious due to Proper amount of backlash is about 0.008 m/m at the tooth face by taking into consideration of off-setting the heat displacement in relation to the accuracy of every moving part involved.

Note: When setting at smaller backlash than 0.005 m/m, be sure to check whether the rotary table can be rotated smoothly by HAND or not.

By the way, backlash of 0.008 m/m at the tooth face means 0.01 m/m at the position of table circumference. At the time of shipment from the factory, backlash is precisely adjusted, however, if necessary, you might be able to adjust it with following procedures:

6-1. Measuring the Amount of Backlash

A. Set a test indicator at the lock-nut near by the circumference of the table as shown below.

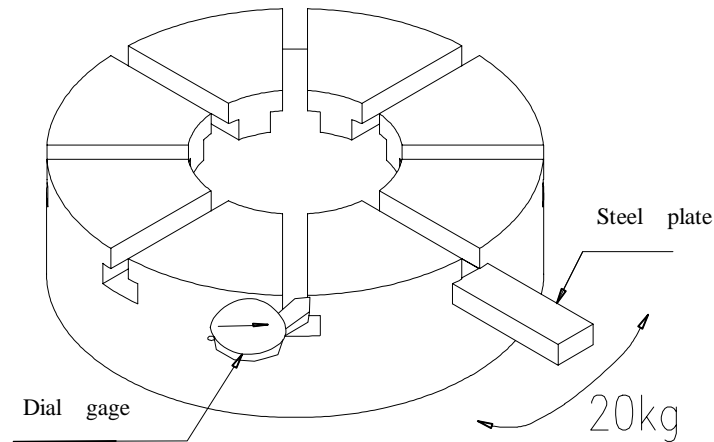

B. Insert the steel plate into the T slot and move back and forth with approximately 20kg force. With the force toward clockwise direction, the test indicator moves, and by releasing the force, it then returns to certain amount. However, this is not the backlash and caused an elastic force occurring at the worm gear and other parts involved. It is the same thing in counterclockwise direction. To obtain the exact amount of backlash, add up the indicator reading of the position after releasing the force both clockwise and anti clockwise direction. In other words, the total amount of indicator travel by force less indicator return after releasing the force is the amount of backlash. But, don't forget to check always both clockwise and clockwise and counterclockwise direction.

Note : In case of adjusting the amount of backlash, an accurate amount of backlash can't be obtained if any play exists at the bearings which support the worm gear. Therefore, remove the worm gear cover shown at the next page and check the play at the next page and check the play at the both O.D. and ace of (A) worm gear shaft with a test indicator. If any play, adjust by tightening the adjusting collar and then check the backlash again.

Note : After adjusted the backlash; make sure again to check the play existence at the face of (A).

C. After adjusted the backlash, if it is much more than 0.01m/m re-adjustment may be required for.

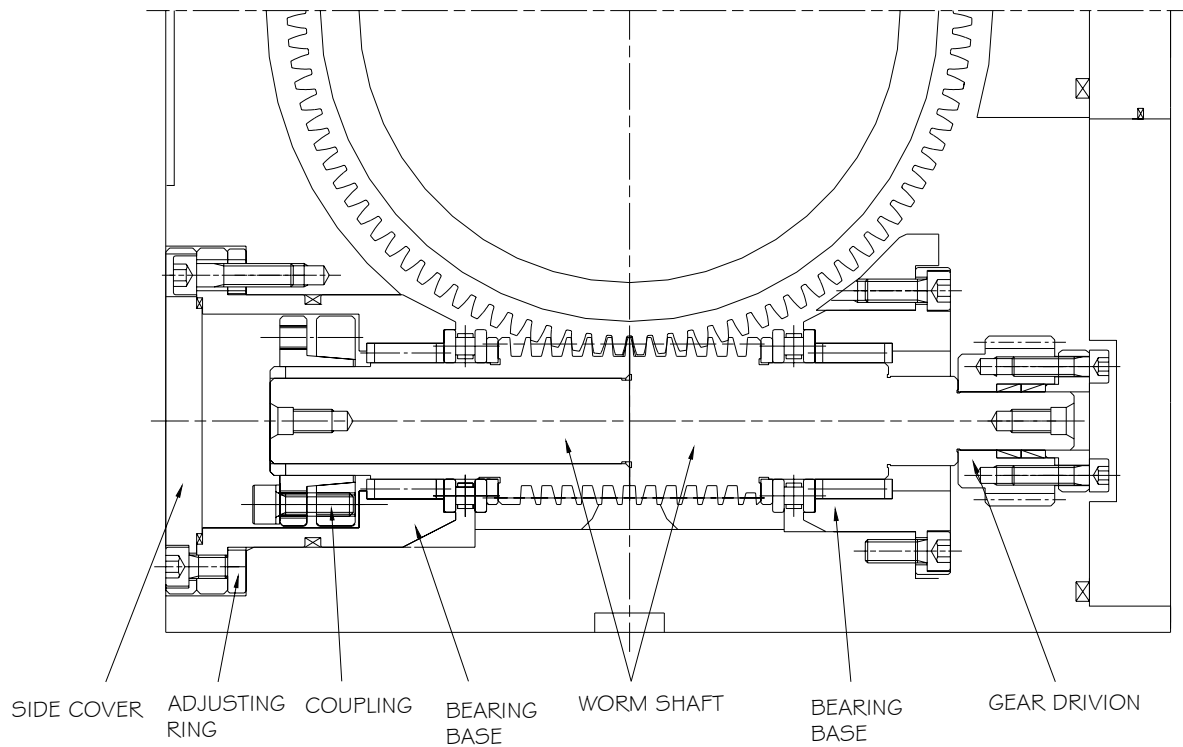

6-2. Adjusting the Amount of Backlash

- a. Remove the cover.
- b. Drain the lubricating oil completely from the unit thru "Oil Outlet".
- c. Remove all of the screws from the motor cover.
- d. By removing 4 pieces. M10 cap screws, the bracket can be removed together with the motor and motor cover. The motor is pretty heavy, and watch out when moving around. Also be careful not to damage the wiring from micro switches or lubricating vinyl hose.
- e. Remove the cover for adjusting the worm.
- f. Loosen 6 pieces hex bolts holding the tightening ring.
- g. The worm gear , consisting of two sections a little by little in view from the end of shaft as shown below:

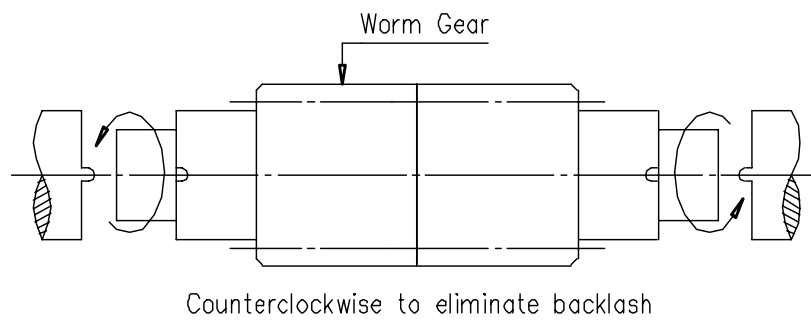

h. After a proper adjustment is done, tighten the hex bolts which hold the adjusting collar, a little by little in order from NO.1 to NO.6 as shown below, and be careful that the tightening ring never contacts the end of bearing support (B).

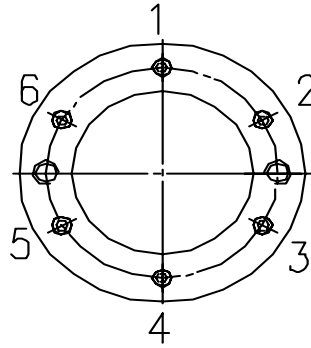

Note: If you tighten too much, it does contact. The tightening ring should be tightened with 4.62 ft. -lbs .torque at the final.

Put all these parts back in the reversed order from e. and on.

In putting the bracket back, wipe off the adhesive material and put new liquid adhesive plaster.

[7] ZERO-RETURN SETTING AND ADJUSTING DOG.

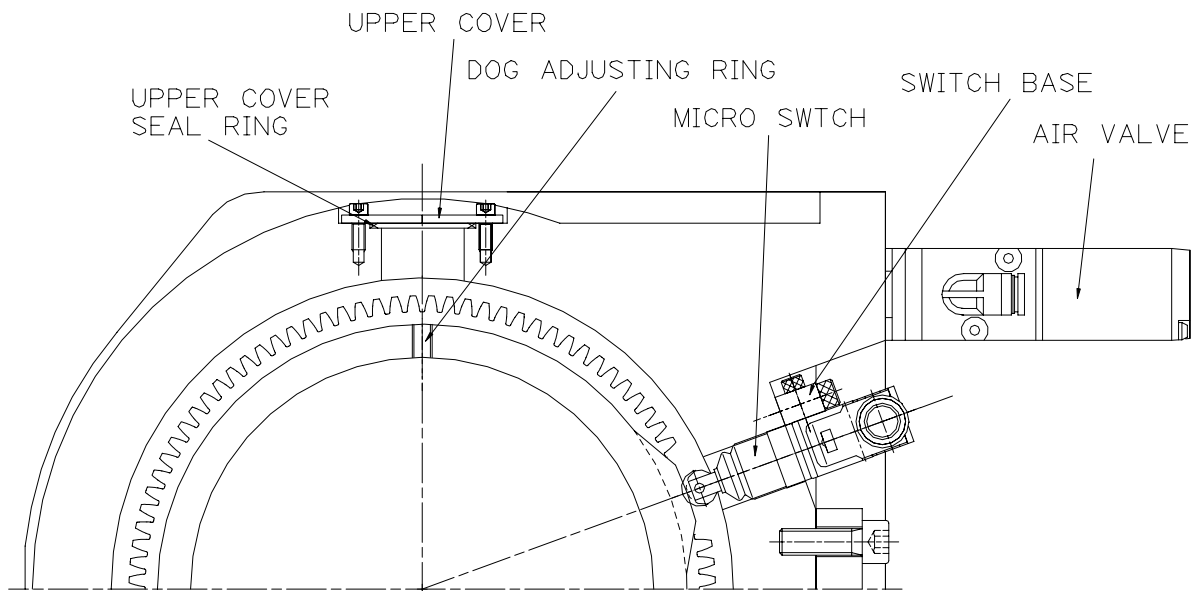

7-1 Zero-Return Setting

To get the single of speed down from the micro switch, when speed stopping it's meaning zero-position.

How to adjust the height of micro switch

- a. Turning back to the home position by clockwise direction.
- b. The switch already set the travel stroke for the micro switch.
- c. When the switch fixed, please install the switch set into the body and test with the connect cable.

7-2 Adjusting Dog

- a. Loosen the screw bolt of the Dog, and through the window to confirm the Dog position.
- b. To adjust the dog to the correct position by clockwise or ccw direction.
- c. Through the parameter setting to get the dog zero-return.

(8). Maintenance and service

Check the following points EVERY MORNING before operation.

- A. Check the oil level, No oil leakage?
- B. Check whether the rotary table is used within the capacities of load (work-piece weight) and cutting force (drive torque).
- C. Check the operation of clamp / unclamp.
- D. No particular noise in table rotation.

(9)EXPLODED VIEW AND PART LIST

9-1

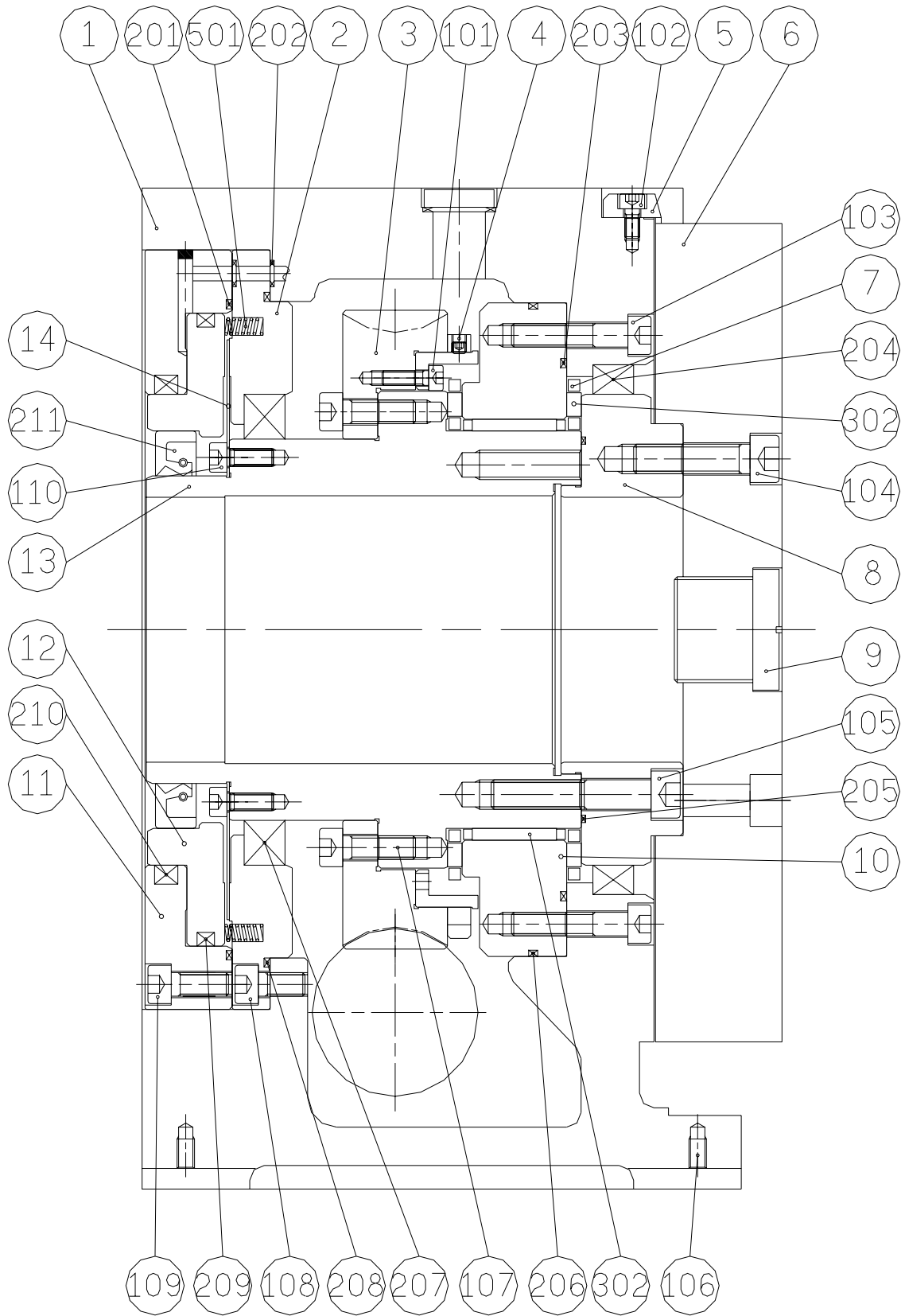

PART LIST

No.	Part No.	Item	Specification	Q'ty	REMARK
001	170501010	Body		1	
002	170502070	Braking Cylinder Cover		1	
003	170502060	Worm Wheel		1	
004	170502050	Sensor Ring		1	
005	160401020	Indicate Cover		1	
006	170502110	Face Plate		1	
007	170502120	Retainer		2	
008	170502020	Spindle Front Cover		1	
009	160401040	Face Plate Plug		1	
010	170502030	Fixed Base		1	
011	170502100	Brake Piston		1	
012	170502090	Brake Cylinder		1	
013	170502010	Spindle		1	
014	170502080	Braking Disc		1	
101		Inner Hexagon Screw	M5×12L	4	
102		Inner Hexagon Screw	M5×12L	1	
103		Inner Hexagon Screw	M8×45L	12	
104		Inner Hexagon Screw	M10×40L	6	
105		Inner Hexagon Screw	M10×55L	6	
106		Inner Hexagon Screw	M5×15L	2	
107		Inner Hexagon Screw	M8×30L	6	
108		Inner Hexagon Screw	M8×20L	6	
109		Inner Hexagon Screw	M8×30L	12	
110		Inner Hexagon Screw	M6×15L	10	
201		O-Ring	AS173	1	
202		O-Ring	P6	2	
203		O-Ring	AS167	1	
204		Spindle Seal	TC16018014	1	
205		O-Ring	S125	1	

206		O-Ring	AS173	1	
207		Spindle Seal	TC13016014	1	
208		O-Ring	AS174	1	
209		O-Ring	AS369	1	
210		O-Ring	AS438	1	
211		Spindle Seal	TC10513514	1	
301		Bearing	K135143335	1	
302		Needle Bearing	Ø5×8L	40	
501		Spring	D6×22L	12	

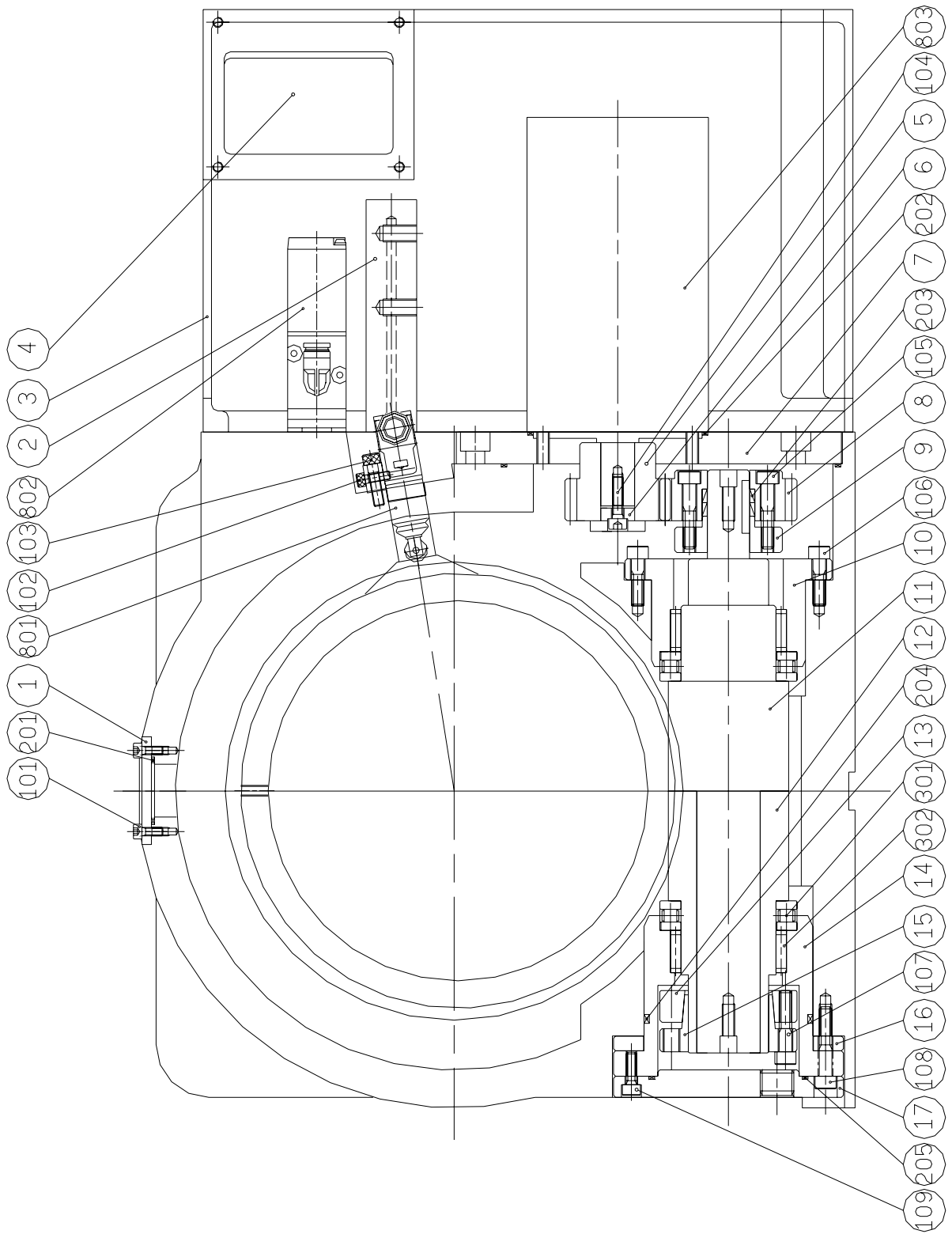

PART LIST

No.	Part No.	Items	Specification	Q'ty	Remark
001	160401010	Body Top Cover		1	
002	160401070	Air Manifold		1	
003	170505010	Motor Cover		1	
004	170405030	Motor Cable Cover		1	
005	170503010	Motor Gear		1	
006	170403080	Fixed Ring		1	
007	170508020	Motor Plate		1	
008	110503140	Worm Shaft Gear		1	
009	110503090	Fixed Base		1	
010	110503060	Right Bearing Base		1	
011	110503040	Worm Shaft (1)		1	
012	110503050	Worm Shaft (2)		1	
013	110503080	Worm Shaft Lock (2)		1	
014	110503030	Left Bearing Base		1	
015	110503070	Worm Shaft Lock (1)		1	
016	110503010	Spacing Ring		1	
017	110503020	Side Cover		1	
101		Inner Hexagon Screw	M4×16L	2	
102		Inner Hexagon Screw	M4×12L	2	
103		Inner Hexagon Screw	M5×20L	2	
104		Inner Hexagon Screw	M5×20L	6	
105		Inner Hexagon Screw	M6×35L	4	
106		Inner Hexagon Screw	M6×25L	6	
107		Inner Hexagon Screw	M7×30L	6	
108		Inner Hexagon Screw	M7×35L	6	
109		Inner Hexagon Screw	M6×20L	3	
201		O-Ring	S26	1	
202		O-Ring	S80	1	
203		Lock Ring	D20×D25×6.3L	2	

204		O-Ring	G75	1	
205		O-Ring	S70	1	
301		Bearing	AZ456514	2	
302		Bearing	TAF455520	2	
801		Home Switch	D4E-E20N	1	
802		Brake Sol. 24 VDC	100E1	1	
803		Motor	P50B08075	1	