

550
-060
-061
-062

UNIVERSAL THREE-WAY ANGLE VISE

Operation and Maintenance

The product has been fully adjusted and has undergone a rigorous inspection before it leaves our factory. Remove the protective oil prior to use. After completion of operations, clean thoroughly, removing all dirt, metal chips, cutting oil, etc. If the vise will be out of service for long, apply protective oil and store in an appropriate place. Rusting is very harmful, resulting in the reduced precision of the equipment.

Specification

1. Max. Tilt (lengthwise): 0° - 90°
2. Max. Tilt (crosswise): 0° - 45° (Right or left)
3. Rotation: 0° - 360°
4. Angle reading graduation: 1°

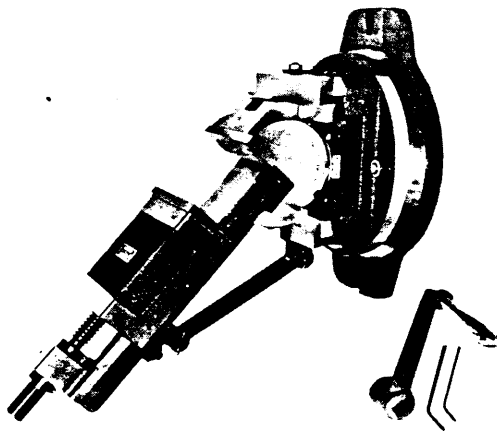

While, with conventional milling vises, the main objective is the firm clamping of a workpiece alone, this "Angle Vise" has extra capabilities which permit multi-dimensional machining operations with a single set-up. For example, once a workpiece is firmly clamped in the vise, no re-setting of the workpiece is required from the first machining process to the end, as the vise can be tilted either lengthwise or crosswise. Special provisions have been made in the design of the tilting mechanism for the maximum stability of the clamping of a workpiece in the tilting position. The base can be rotated 360°.

Standard Accessories

Hexagonal wrench keys... G3, G4 and (G5, 550-060)

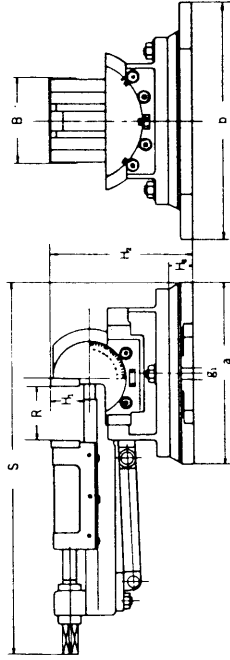

Dimensions

Stock No	Width of jaw	Opening of jaws	Height of mouth piece	Overall length	Height at horizontal position	Height at vertical position	Height of swiveling base	Mounting base	Weight
550-060	80	90	30	280	144	385	28	1178 × 234	10
	315	354	118	1102	567	1516	110	701 × 921	22.0
550-061	105	105	40	456	172	464	30	222 × 299	22
	413	413	157	1795	677	1827	118	874 × 1177	48.4
550-062	130	145	52	566	204	585	33	250 × 326	42
	512	571	205	2028	803	2303	130	984 × 1283	19.06

Unit: mm/in.

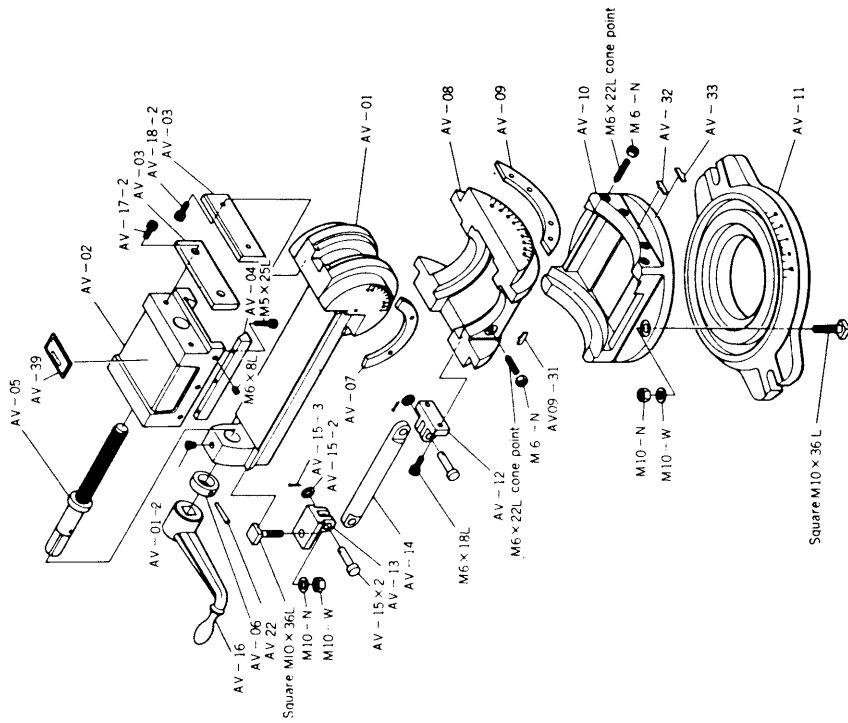

Parts No. and Parts Names

- AV-01 Vise Body
- AV-02 Moving Body
- AV-03 Clamping Jaw
- AV-04 Moving Body Slide Guide
- AV-05 Clamping Screw
- AV-06 Collar

- AV-07 Tilting Stopper (for Vise Body)
- AV-08 Tilting Table
- AV-09 Tilting Stopper (for Tilting Table)
- AV-11 Swiveling Base
- AV-16 Handle
- AV-36 Vise Body Clamp Bolt

*** Suggestions for Ordering**

The parts No. & parts names expressed in the operation and service manual are abbreviated for description. Therefore, when ordering parts for replacement, be sure to specify article marks, article Nos. and component Nos., which are shown in the table of Order No. & Dimensions.



When ordering parts for a product purchased a long time ago, specify its serial No. Operation and Service Manual No. together with the above-mentioned Nos., since the number is useful for checking their design changes. (N. B.) When ordering parts in accordance with the exploded view No. and the like given in the catalog of a single product or all products, be sure to write in addition its page so as to distinguish from the Operation and Service Manual No.

Components

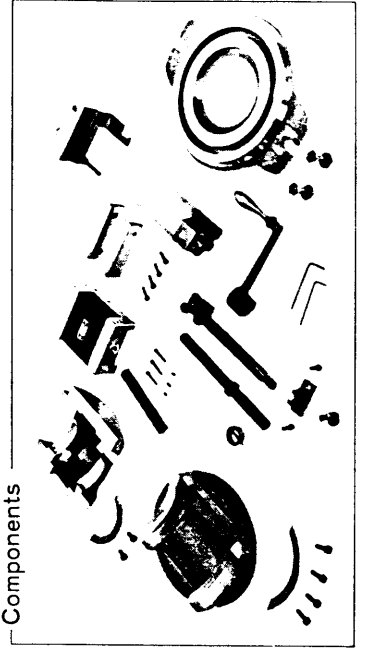

Operating Instructions and Functions of Each Unit

(1) Tilting Vice lengthwise

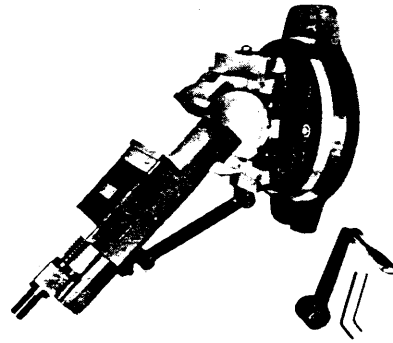

To tilt the Vice lengthwise, loosen the Clamp Nut for the Support located under the Vice Body and the Tilting Stopper Set-Screw. Tilt the Vice for a required angle, tighten the above Support Clamp Nut, the Tilting Stopper Set-Screw and Hex. Lock Nut. The Vice can be tilted over the range of 0° to 90°.

(2) Clamping of a workpiece

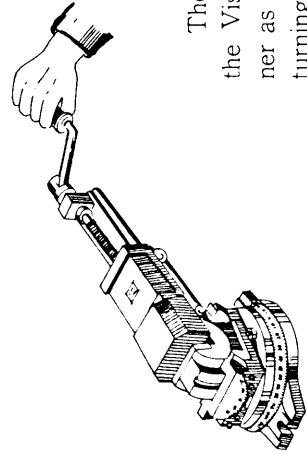

The clamping of a workpiece in the Vice is done, in the same manner as conventional milling vises, by turning the Handle.

(3) Swiveling Base

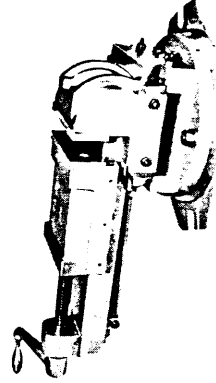

Angle setting of the Swiveling Base is accomplished by loosening the Hex. Bolt on this base and rotating the Vice to a suitable position. When angle setting is done, retighten the above Hex. Nut. The Swiveling Base is rotatable over the range of 0° to 360°.

(4) Tilting Vice crosswise

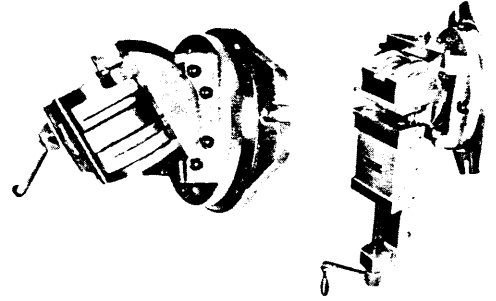

To tilt the Vice crosswise, loosen a Gib Set-Screw and tilt the Vice Body for a specific angle. Then tighten the Tilting Stopper Set-Screw and Hex. Lock Nut. The Vice can be tilted crosswise 0° to 45°.

Working Example

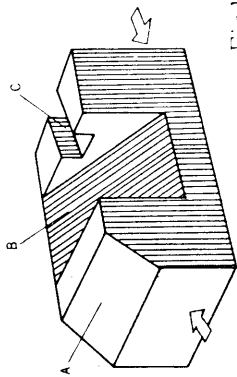

Fig 1

In order to demonstrate how to operate the Vise, here is a machining example where the surface "A" is to be milled to 30° angle, the surface "B" to 40° angle and the portion "C" is to be grooved 90° in relation to the surfaces to be clamped in the Vise:

1. The workpiece is clamped in the Vise, with the arrowmarked surfaces contacting the Clamping Jaws. At this time the Vise is in the horizontal position.
2. To machine the surface "A", the Vise must be tilted 30° lengthwise. Before working on the workpiece, be sure that the Vise Tilting Set-Screw and Lock Nut and the Support under the Vise Body have been securely tightened. (Chamfering operation.)

3. Now the surface "B" is to be milled. Return the Vise to the original horizontal position. Then tilt the Vise 40° crosswise. Be sure to tighten the Tilting Table Set-Screw and Lock Nut before starting to work. (Grooving operation.)

4. To work on the surface "C", again return the Vise to the original position and rotate the Swiveling Base 90°. The Hex. Nut must be tight before working. (Grooving operation)

5. The cycles 1 through 4 above complete all the specified machining operations. Thus, this Vise allows the operator to complete the 1st process through the 3rd without unclamping the workpiece in between. Therefore, it by far excels any conventional milling vise which requires re-setting of a workpiece for each machining process, in that it cuts the machining time remarkably and offers a great advantage for a job involving angles difficult to machine.

